

Jumper Square, 150x150cm

JUM104

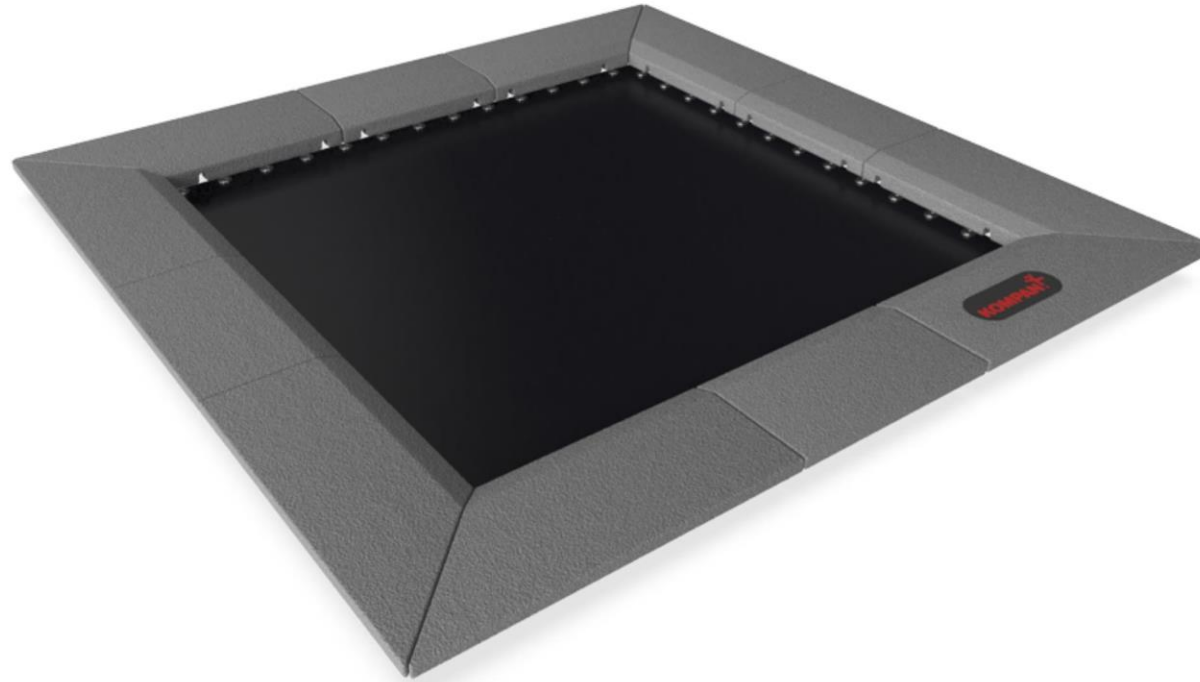

Item no. JUM10401-0301

General Product Information

Dimensions LxWxH	210x210x0 cm
Age group	4+
Play capacity (users)	1
Colour options	



Bouncing on the Jumper Square is one of the most popular activities of the playground. The children will be highly attracted to the immediate response of the Jumper to their movements and jump repeatedly. The small measure of the Jumper makes it perfect as playground "glue", connecting activities when put together in paths. This will support games

like The Ground is Lava. Jumping is a fantastic activity for motor skills such as balance, proprioception and rhythm. When jumping up and down, all big muscle groups get trained. The jumping on and off the Jumper additionally builds bone density. Bone density is primarily built during early youth, so to build strong bones for life, children should take as much

weight bearing activity as they can. There are few ways funnier than the responsive Jumper. With assistance, non-motorized wheelchairs can be assisted onto the Jumper for a gently bouncing experience.



Data is subject to change without prior notice.

Jumper Square, 150x150cm

JUM104

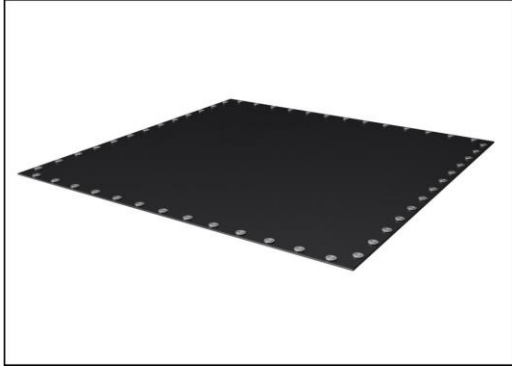

The jumping membranes are made of 6,0mm thick EP Ethylene-Propylene conveyor belt with polyester polyamide fabric carcass. Spring fixations are reinforced with steel bushings and washers on both sides. The membrane is ozone resistant and equipped with 5 center placed water drain holes.



All 52 springs are made of stainless steel to ensure durability and excellent corrosion resistance. The steel wire is 3,2 mm thick and the last five windings are cone shaped to ensure long lifetime of the jumper.



The tiles are molded in grey SBR recycled rubber, Styrene Butadiene Monomer rubber, and the KOMPAN logo is made of EPDM Ethylene Propylene Diene Monomer. Inside each of the rubber tiles there is a 3 mm hot dip galvanized steel plate.



All steel components are manufactured from carbon steel S235 in a thickness of 3 mm. Side panels, support walls for top frame, plates bended with SBR and plates flat for in-situ surfacing are hot dip galvanized.

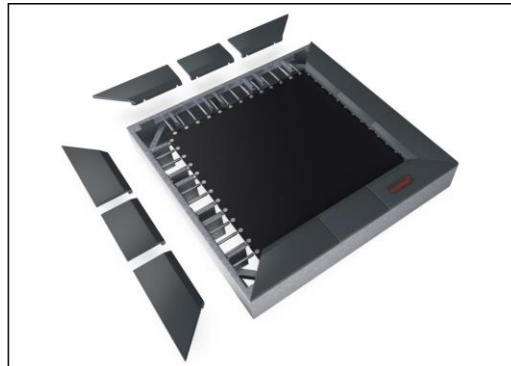

As a unique feature the SBR tiles can be removed for cleaning and service. By loosening six screws the SBR tile can be lifted up to open and gain access to the springs (see instruction on KOMPAN Master).

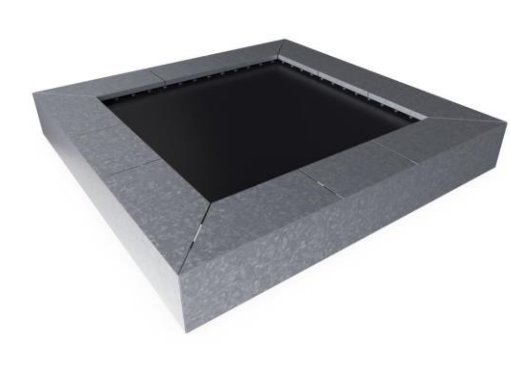

If customized colors of the surfacing is requested all jumpers can be ordered with steel plates suitable for in situ surfacing in preferred color. For in situ installations there is no service opening option.

Item no. JUM10401-0301

Installation Information

Max. fall height	100 cm
Safety surfacing area	26,8 m ²
Numbers of installers (persons)	2
Total installation time	4.1
Excavation volume	1,86 m ³
Concrete volume	0,11 m ³
Footing depth (standard)	60 cm
Shipment weight	362 kg
Anchoring options	In-ground ✓

Warranty Information

Hot dip galvanised steel	Lifetime
Jumper springs	2 years
Jumping bed material	2 years
SBR rubber	2 years
Spare parts guaranteed	10 years



Jumper Square, 150x150cm

JUM104

* Max fall height | ** Total height | *** Safety surfacing area

* Max fall height | ** Total height

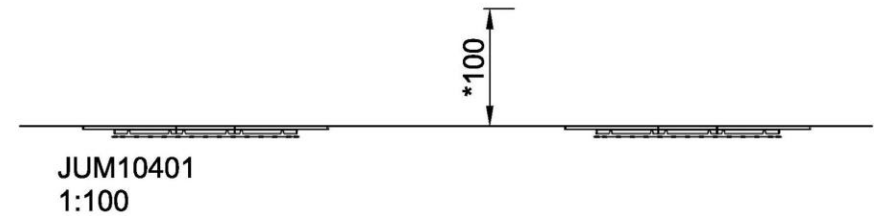
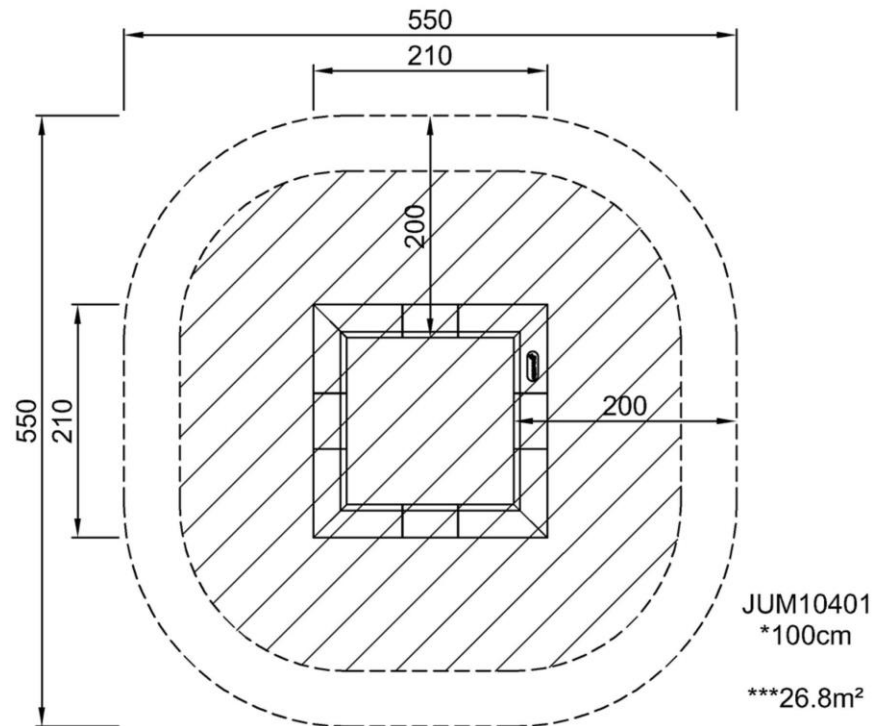

[Click to see 1:100 ratio TOP VIEW](#)

[Click to see 1:100 ratio SIDE VIEW](#)

Jumper Square, 150x150cm

JUM104



Bouncy floor

Physical: trains motor skills ABC: agility, balance and coordination, as well as proprioception and rhythm when jumping on and off. Bone density is built when jumping on and off.

Social-Emotional: turn-taking and cooperation skills when timing when to jump in and out, one after the other.

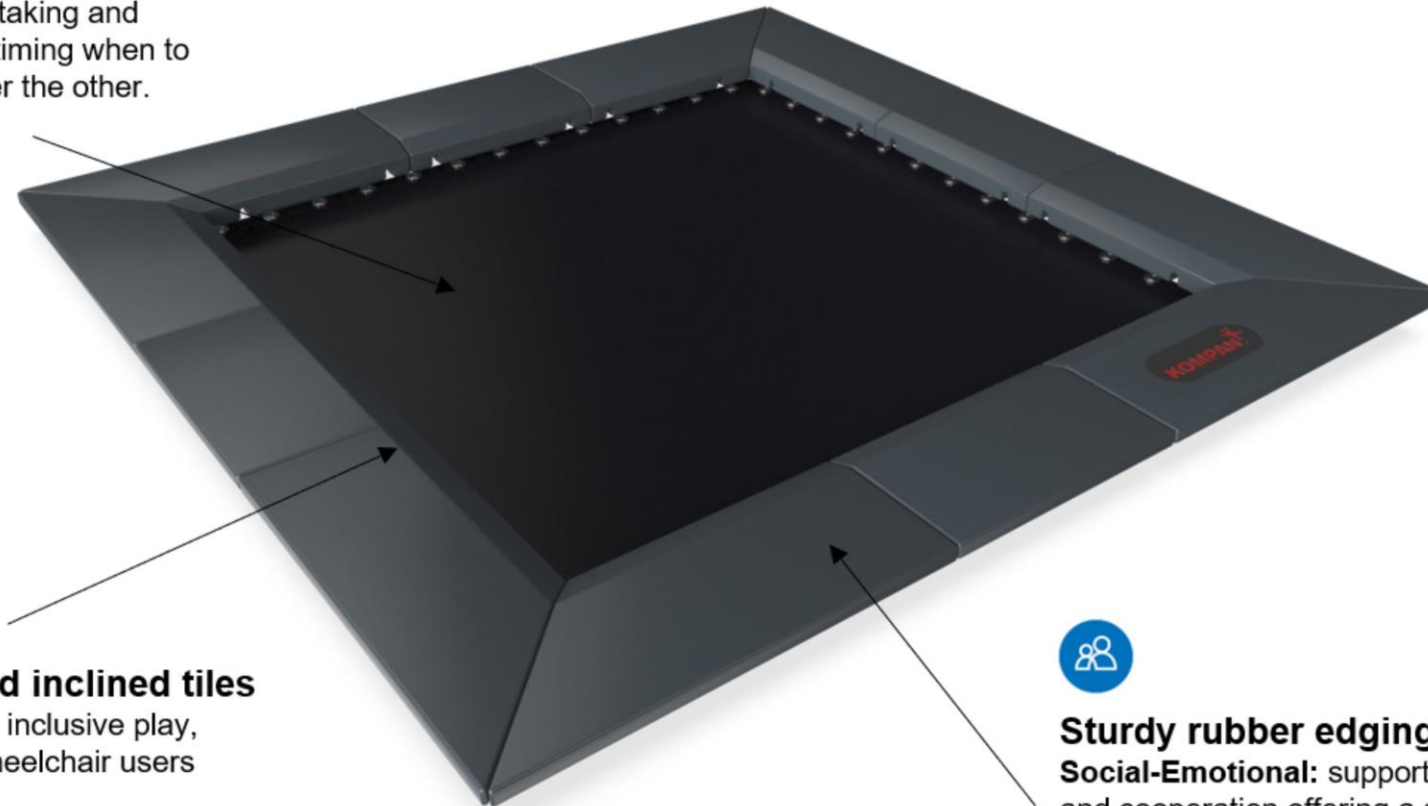

Size of membrane and inclined tiles

Social-Emotional: support inclusive play, allowing accessibility for wheelchair users onto the Jumper floor.



Sturdy rubber edging

Social-Emotional: supports turn-taking skills and cooperation offering a sturdy, yet softer waiting and observing space for children about to enter.

Jumper Square, 150x150cm

JUM104



PHYSICAL

Joy of movement:
motor skills, muscle, cardio
and bone density



SOCIAL-EMOTIONAL

Joy of being together:
teamwork, tolerance and
sense of belonging



COGNITIVE

Joy of learning:
curiosity, understanding of causal
relationships and knowledge of the world



CREATIVE

Joy of creating:
co-creation and experimenting
with materials



BALANCE

To balance is to stay upright when walking or standing on a surface that makes this challenging (e.g. a wobbly, inclined, or narrow surface).



HANG IN ARMS

To hang in arms is the act of carrying the body with the hands or arms, possibly to traverse to another platform or play item.



SENSORY

To sense is the act of taking in information with the sensory system: seeing, feeling, hearing or sensing with the body.



BOUNCE

To bounce is the act of bouncing on a responsive, flexible, elastic or tensile surface.



JUMP

To jump is the act of jumping up or down on a hard surface.



SLIDE

To slide is the act of moving fast downwards seated on a slide.



CLIMB

To climb is the act of moving upwards, cross-coordinating arms and legs, on a vertical or inclined surface or net.



PULL

To pull is the act of pulling an item towards you or you towards an item with one or both hands, or possibly using the entire body.



SOCIALIZE

To socialize is the act of meeting, communicating or cooperating in an activity that stimulates and facilitates social interaction.



CONSTRUCT

To construct is the act of creating new patterns, shifting items or materials to new positions or constructing with materials that can be transformed or manipulated.



PUSH

To push is the act of pushing an item away from you with one or both hands, possibly with the entire body.



SPIN

To spin involves a fast, repeated horizontal or vertical turn of the body on a piece of equipment that facilitates the movement.



CRAWL

To crawl is the movement of moving forwards or backwards, cross-coordinating arms and legs, on a horizontal or slightly inclined surface.



ROCK

To rock is the action of rocking back and forth, or sideways, on e.g. a piece of spring equipment.



SWAY

To sway is the movement of swaying back and forth, or around, lying, seated or possibly standing, in a pendulant or circular movement, e.g. on a hammock or on a rope.



DRAMATIC PLAY

Dramatic play is motivated through play items that stage a frame, place or environment for acting out make believe or role play scenarios.



ROTATE

To rotate involves a vertical or horizontal slower paced turn of the body, facilitated by a piece of equipment.



SWING

To swing is the movement of swinging back and forth, or in circular movement, seated, standing or lying, in an unhindered arc.



GLIDE

To glide is the act of moving from one point to another without shifting the feet, in a horizontal or vertical movement, in a seated, lying or standing position, letting gravity do the work.



RULES PLAY

Rules play is motivated through play items that suggest games-with-rules, cooperation and team work, e.g. tic-tac-toe, timers or ball games.



WONDER

To wonder is motivated through play items that make children need and use their logical, abstract or creative thinking skills, as well as their memory.